







**IDU-BS-G** is an indoor AC/DC PoE injector with built-in lightning protection compatible with R5000-Smn, R5000-Lmn, R5000-Omx, R5000-Mmx models and AUX-ODU-SYNC synchronization hub.

**IDU-BS-G** is powered by an AC supply in the 100-240 V range. Built-in lightning protection protects units connected to PoE injector.



## Key Features

-  Compatible with R5000-Smn, R5000-Lmn, R5000-Omx, R5000-Mmx models and AUX-ODU-SYNC
-  Gigabit Ethernet pass-through
-  Operating temperature range: from 0°C to +40°C

-  AC power source
-  Input voltage: 100 - 240 V
-  Output voltage: +56 V
-  Consumption: 50.4 W

## Recommended Installation Layout

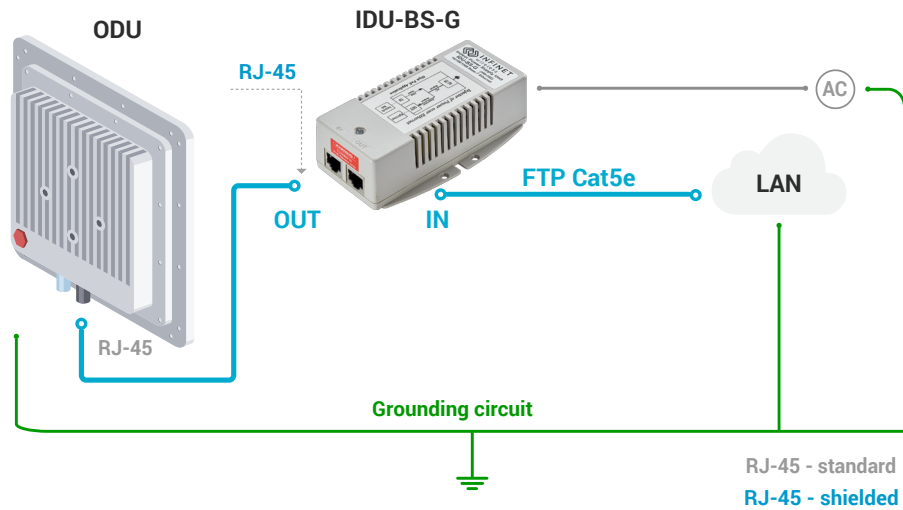

## Specification

Parameter		Description							
Compatible models		R5000-Smn, R5000-Lmn, R5000-Omx, R5000-Mmx, AUX-ODU-SYNC Supplied by default with R5000-Omx and R5000-Mmx models							
Input Voltage		100 - 240 V							
Output Voltage & Current		+56 V, 0.9 A							
Consumption		50.4 W							
Supported Ethernet Modes		10/100/1000 Mbps (Gigabit Ethernet pass-through)							
Connectors and Interfaces		<ul style="list-style-type: none"> <li>• "ETH IN" - Ethernet input (Data only)</li> <li>• "ETH OUT" - Ethernet output (Data+VDC), PASSIVE PoE</li> <li>• "PWR" - AC Input</li> </ul>							
Pin Assignment and Polarity	ETH IN	1	2	3	4	5	6	7	8
		A+	A-	B+	C+	C-	B-	D+	D-
	ETH OUT	1	2	3	4	5	6	7	8
		A+	A-	B+	+VDC / C+	+VDC / C-	B-	-VDC / D+	-VDC / D-
EMC		<ul style="list-style-type: none"> <li>• FCC Class B</li> <li>• EN55022 Class B</li> </ul>							
Lightning Protection		<ul style="list-style-type: none"> <li>• IEC 61000-4-2 (ESD) 15kV (air), 8kV (contact)</li> <li>• IEC 61000-4-4 (EFT) 40A (tp = 5/50ns)</li> <li>• IEC 61000-4-5 (Lightning) L5, 95A (tp = 8/20us)</li> </ul>							
Size and Weight		125x72x38 mm, 0.3 kg							
Operating temperature range		from 0°C to +40°C							